

TORQUE SPECIFICATIONS			
ITEM	FT-LB	IN-LB	N-M
1			
2			
3			
4			
5			
6			
7			
8			
9			
10			
11			
12			
13			
14			
15			
16			
17			
18			
19			
20			
21			
22			
23			
24			
25			
26			
27			
28			
29			
30			
31			
32			
33			
34			
35			
36			
37			
38			
39			
40			
41			
42			
43			
44			
45			
46			
47			
48			
49			
50			
51			
52			
53			
54			
55			
56			
57			
58			
59			
60			
61			
62			
63			
64			
65			
66			
67			
68			
69			
70			
71			
72			
73			
74			
75			
76			
77			
78			
79			
80			

ITEM	PART NO.	DESCRIPTION	QTY
1	7000123	SCREEN, WATER INLET	1
2	7105704	CONNECTOR, WATER INLET	1
3	7105705	NUT, HAND TIGHT	1
4	7000325	SCREW	3
5	7104692	SCREW	3
6	7005061	SCREW, SET	1
7	7101359	VALVE, THERMAL RELIEF	1
8	7105706	MANIFOLD	1
9	N/A	NUT, UNLOADER JAM	1
10	N/A	NUT, UNLOADER ADJUSTMENT	1
11	N/A	SPRING, UNLOADER	1
12	N/A	GUIDE BUSHING UNLOADER	1
13	7105707	O-RING	2
14	N/A	BACK-UP RING, UNLOADER VALVE	1
15	N/A	O-RING	1
16	N/A	STEM, UNLOADER	1
17	N/A	O-RING	1
18	N/A	BACK-UP RING, SPLIT	1
19	7105708	VALVE SEAT	1
20	7105709	O-RING	1
21	7105710	BALL, UNLOADER VALVE	1
22	7105711	BODY, SOAP INJECTOR	1
23	7105712	CAP, BOOST VALVE	1
24	7105713	SPRING, BOOST VALVE	1
25	7107486	VALVE, PRESSURE BOOST 1.5MM	1
26	7105715	O-RING	1
27	7105716	O-RING	1
28	N/A	SPRING, CHECK VALVE	1
29	N/A	CHECK VALVE	1
30	N/A	O-RING	1
31	N/A	FITTING, SOAP INJECTION	1
32	N/A	O-RING	1
33	N/A	O-RING	1
34	N/A	BALL, SOAP VALVE	1
35	N/A	SPRING, SOAP VALVE	1
36	7105717	PLUG MANIFOLD	3
37	7105718	O-RING	5
38	N/A	CAGE, VALVE	6
39	N/A	SPRING, VALVE	6
40	N/A	DISK, VALVE	6

ITEM	PART NO.	DESCRIPTION	QTY
41	N/A	SEAT, VALVE	6
42	N/A	O-RING	6
43	N/A	SEAL HIGH PRESSURE	3
44	N/A	RING, ANTI-EXT	3
45	7105719	RETAINER	3
46	N/A	O-RING	3
47	N/A	SEAL, LOW PRESSURE	3
48	7105720	RETAINER, SEAL	3
49	N/A	SEAL, OIL	3
50	7105721	PLUG, CRANKCASE	2
51	7105722	SEAL, OIL	1
52	7105723	RING, RETAINING	1
53	7105724	BEARING, CRANKSHAFT	1
54	7103426	SCREW	1
55	-	CRANKSHAFTS	-
-	7105725	CRANKSHAFT 8.7GA12	1
-	7105726	CRANKSHAFT, 9.6GA12	1
56	7105727	BEARING, CRANKSHAFT	1
57	7105729	RING, RETAINING	1
58	N/A	O-RING	1
59	7105918	SIGHT GLASS	1
60	7105919	CRANKSHAFT, SIDE COVER	1
61	N/A	RING, RETAINING	1
63	N/A	SCREW	7
64	7105920	GASKET	1
65	7105730	CONNECTING ROD	3
66	7105731	PIN, CONNECTING ROD	3
67	7105732	PISTON, CERAMIC COATED	3
68	7105733	CRANKCASE, PUMP	1
70	7105922	CRANKCASE, END COVER	1

ITEM	PART NO.	DESCRIPTION	QTY
71	7104223	VALVE KIT	6
72	7104228	SOAP INJECTOR KIT	1
73	7105739	UNLOADER KIT	1
74	7105740	UNLOADER CHECK VALVE KIT	1
75	7105741	OIL SEAL KIT	1
76	7105742	HIGH AND LOW PRESSURE SEAL KIT	1
77	7105921	CRANKCASE SIDE COVER KIT	1
78	7105745	MANIFOLD KIT	1
79	7105936	CRANKCASE KIT	1
80	7107484	OUTLET FITTING KIT	1

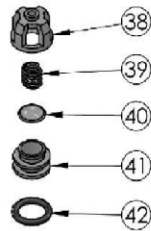

7104223
ITEM 71 VALVE KIT

ITEM	QTY	DESCRIPTION
38	5	CAGE, VALVE
39	5	SPRING, VALVE
40	5	DISK, VALVE
41	5	SEAT, VALVE
42	5	O-RING

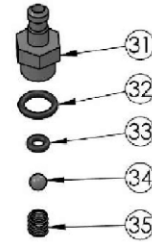

7104228
ITEM 72 SOAP INJECTOR KIT

ITEM	QTY	DESCRIPTION
31	1	FITTING, SOAP INJECTION
32	1	O-RING
33	1	O-RING
34	1	BALL, 3/16" SOAP VALVE
35	1	SPRING, SOAP VALVE

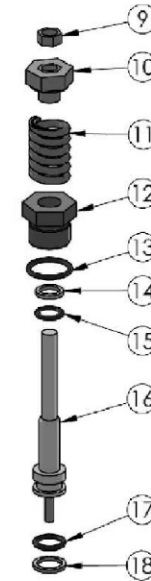

7105739
ITEM 73 UNLOADER KIT

ITEM	QTY	DESCRIPTION
9	1	NUT, UNLOADER JAM
10	1	NUT, UNLOADER ADJUSTMENT
11	1	SPRING, UNLOADER
12	1	GUIDE PUSHING, UNLOADER
13	1	O-RING
14	1	BACK-UP RING, UNLOADER VALVE
15	1	O-RING
16	1	STEM, UNLOADER
17	1	O-RING
18	1	BACK-UP RING, SPLIT

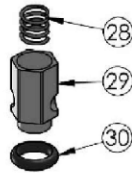

7105740
ITEM 74 UNLOADER CHECK VALVE KIT

ITEM	QTY	DESCRIPTION
28	1	SPRING, CHECK VALVE
29	1	CHECK VALVE
30	1	O-RING



7105741
ITEM 75 OIL SEAL KIT

ITEM	QTY	DESCRIPTION
49	3	SEAL, OIL

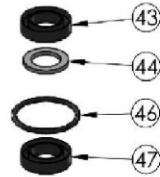

7105742
ITEM 76 HIGH AND LOW PRESSURE SEAL KIT

ITEM	QTY	DESCRIPTION
43	3	SEAL, HIGH PRESSURE
44	3	RING, ANTI-EXT
46	3	O-RING
47	3	SEAL, LOW PRESSURE

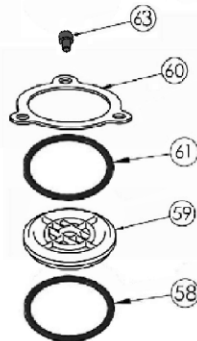

ITEM 77 CRANKCASE END COVER KIT

PART NO.	DESCRIPTION
7105921	CRANKCASE SIDE COVER KIT

ITEM	QTY	DESCRIPTION
58	1	O-RING
59	1	SIGHT GLASS
61	1	O-RING (F18)
60	1	CRANKCASE, SIDE COVER
65	3	SCREW

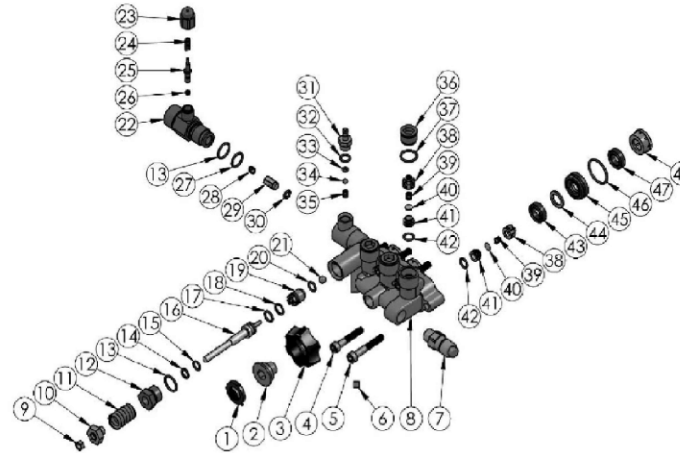

7105745
ITEM 78 MANIFOLD KIT

ITEM	QTY	DESCRIPTION
1	1	SCREEN, WATER INLET
2	1	CONNECTOR, WATER INLET
3	1	NUT, HAND TIGHT
4	3	SCREW
5	3	SCREW
6	1	SCREW, SET
7	1	VALVE, THERMAL RELIEF
8	1	MANIFOLD
9	1	NUT, UNLOADER JAM
10	1	NUT, UNLOADER ADJUSTMENT
11	1	SPRING, UNLOADER
12	1	GUIDE BUSHING, UNLOADER
13	2	O-RING
14	1	BACK-UP RING, UNLOADER VALVE
15	1	O-RING
16	1	STEM, UNLOADER
17	1	O-RING
18	1	BACK-UP RING, SPLIT
19	1	VALVE SEAT
20	1	O-RING
21	1	BALL, UNLOADER VALVE
22	1	BODY, SOAP INJECTOR
23	1	CAP, BOOST VALVE
24	1	SPRING, BOOST VALVE

ITEM	QTY	DESCRIPTION
25	1	VALVE, PRESSURE BOOST
26	1	O-RING
27	1	O-RING
28	1	SPRING, CHECK VALVE
29	1	CHECK VALVE
30	1	O-RING
31	1	FITTING, SOAP INJECTION
32	1	O-RING
33	1	O-RING
34	1	BALL, 3/16 SOAP VALVE
35	1	SPRING, SOAP VALVE
36	3	PLUG, MANIFOLD
37	3	O-RING
38	6	CAGE, VALVE
39	6	SPRING, VALVE
40	6	DISC, VALVE
41	6	SEAT, VALVE
42	6	O-RING
43	3	SEAL, HIGH PRESSURE
44	3	RING, ANTI-EXT
45	3	RETAINER
46	3	O-RING
47	3	SEAL, LOW PRESSURE
48	3	RETAINER SEAL

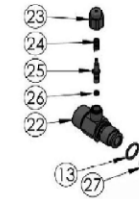

7107484
ITEM 80 OUTLET FITTING KIT

ITEM	QTY	DESCRIPTION
23	1	CAP, BOOST VALVE
24	1	SPRING, POWER BOOST VALVE
25	1	VALVE, PRESSURE BOOST
26	1	O-RING
22	1	BODY, SOAP INJECTOR
13	1	O-RING
27	1	O-RING

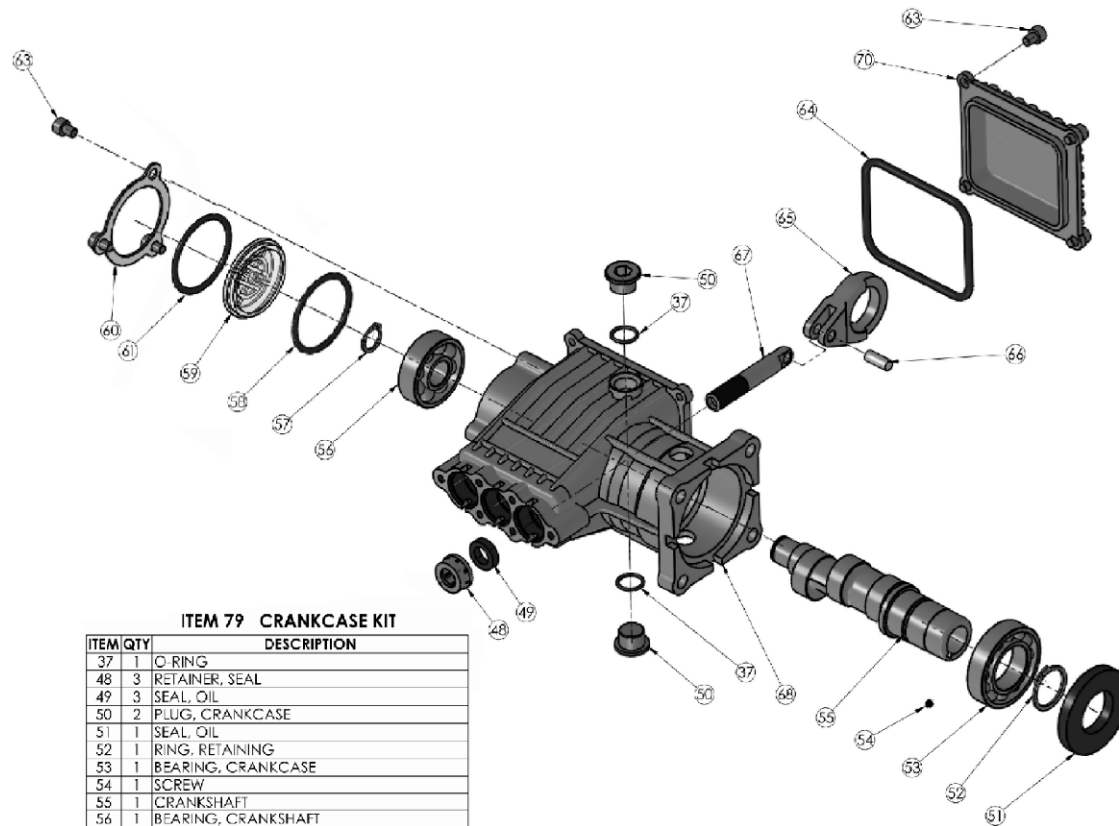

ITEM 79 CRANKCASE KIT

ITEM	QTY	DESCRIPTION
37	1	O-RING
48	3	RETAINER, SEAL
49	3	SEAL, OIL
50	2	PLUG, CRANKCASE
51	1	SEAL, OIL
52	1	RING, RETAINING
53	1	BEARING, CRANKCASE
54	1	SCREW
55	1	CRANKSHAFT
56	1	BEARING, CRANKSHAFT
57	1	RING, RETAINING
58	1	O-RING
59	1	SIGHT GLASS
60	1	CRANKCASE SIDE COVER
61	1	RETAINING RING
63	7	SCREW
64	1	GASKET
65	3	CONNECTING ROD
66	3	PIN, CONNECTING ROD
67	3	PISTON, CERAMIC COATED
68	1	CRANKCASE HOUSING
70	1	CRANKCASE, END COVER